

Automatic flow regulator with high-resistance polymer cartridge

121 - 126 series



AutoFlow®



cert. n° 0003
ISO 9001

01141/06 GB



Function

The AutoFlow devices are automatic flow regulators capable of maintaining a constant flow rate of the medium as the operating conditions of the hydronic circuit change. They automatically balance the hydronic circuit and ensure the design flow rate at each terminal emitter.

In this particular series, the devices are equipped with an innovative and exclusive regulator element made of high-resistance polymer, selected for use in air-conditioning and plumbing systems.

With this new regulator, the devices provide silent operation, accuracy in control, insensitivity to scale and a long service life.

The devices are available in both the version as a flow regulator and in the version completed with a shut-off ball valve.

Patent application No. MI2004A001549

Product range

121 series Automatic flow regulator with high-resistance polymer cartridge and ball valve _____ sizes 1/2" - 3/4" - 1" - 1 1/4"
126 series Automatic flow regulator with high-resistance polymer cartridge _____ sizes 1/2" - 3/4" - 1" - 1 1/4"

Technical specifications

| series ↘ | 121 | 126 |
|--|---|--|
| Materials Body: Autoflow cartridge: Spring: Seals: Ball: Ball seat: Control stem seal: Lever: Pressure port plugs: | brass EN 12165 CW617N high-resistance polymer stainless steel EPDM brass EN 12165 CW614N, chrome-plated PTFE PTFE special zinc-plated steel POM | brass EN 12165 CW617N high-resistance polymer stainless steel EPDM - - - special zinc-plated steel POM |
| Performance Medium: Maximum percentage of glycol: Maximum working pressure: Working temperature range: Δp Range: Flow rates: Accuracy: | water, glycol solutions 50% 16 bar 0-100°C 15-200 kPa 0,12-2,0 m³/h ±10% | water, glycol solutions 50% 16 bar 0-100°C 15-200 kPa 0,12-2,0 m³/h ±10% |
| Connections | 1/2"-1 1/4" F with union x F | 1/2"-1 1/4" F |
| Pressure ports connections | 1/4" F | 1/4" F |

Dimensions

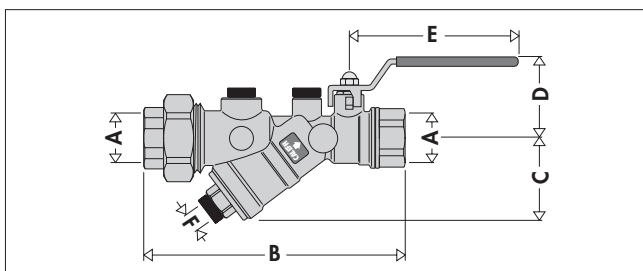

| Code | A | B | C | D | E | F | Weight (kg) |
|------------|--------|-------|----|----|-----|------|-------------|
| 121141 ... | 1/2" | 156,5 | 50 | 50 | 100 | 1/4" | 1,00 |
| 121151 ... | 3/4" | 159,5 | 50 | 50 | 100 | 1/4" | 1,00 |
| 121161 ... | 1" | 218,5 | 96 | 66 | 120 | 1/2" | 1,85 |
| 121171 ... | 1 1/4" | 220,5 | 96 | 66 | 120 | 1/2" | 1,87 |

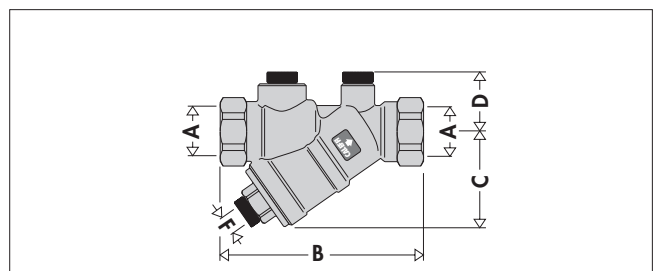

| Code | A | B | C | F | Weight (kg) |
|------------|--------|-----|----|------|-------------|
| 126141 ... | 1/2" | 101 | 50 | 1/4" | 0,45 |
| 126151 ... | 3/4" | 106 | 50 | 1/4" | 0,48 |
| 126161 ... | 1" | 140 | 96 | 1/2" | 1,36 |
| 126171 ... | 1 1/4" | 148 | 96 | 1/2" | 1,24 |

Circuit balancing

Modern heating and air-conditioning systems have to guarantee a high level of thermal comfort with a low consumption of energy. This means supplying the system terminal emitters with the correct design flow rates, to produce balanced hydraulic circuits.

Unbalanced circuits

If a circuit is not balanced, the hydraulic imbalance between emitters creates areas with temperatures which are not uniform, problems with thermal comfort, and higher energy consumption.

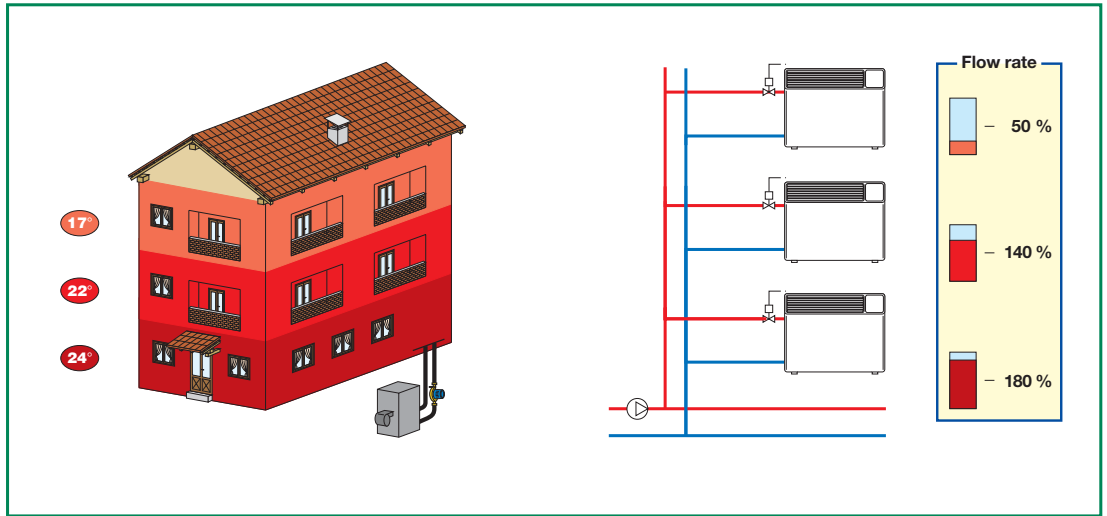

Circuits balanced with manual valves

Traditionally, hydraulic circuits are balanced using manual calibration valves. With these static-type devices, such circuits are difficult to balance perfectly and have operating limitations in the case of partial closure by means of the regulating valves. The flow rate in the open circuits **does not remain constant at the nominal value.**

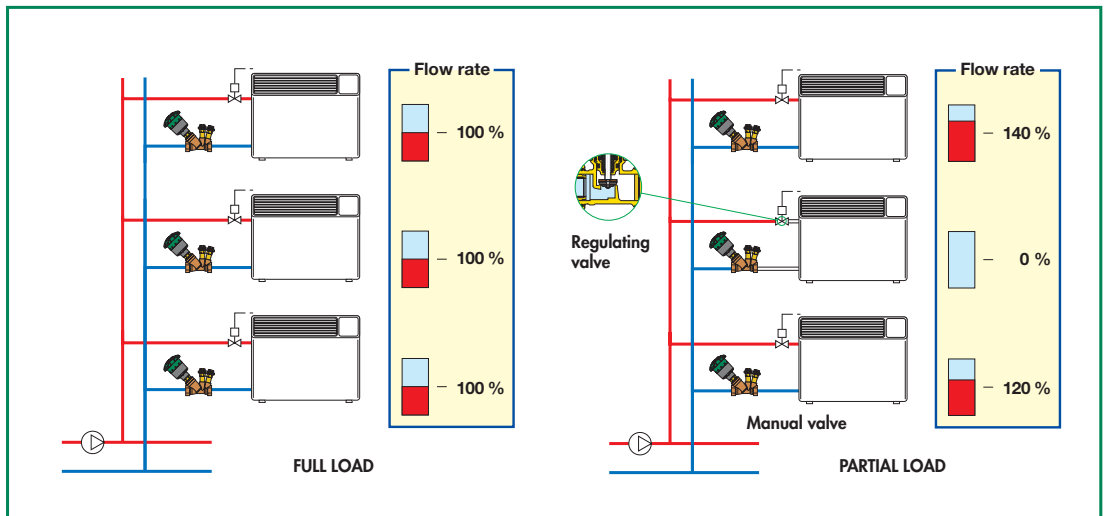

Circuits balanced with Autoflow

Autoflow balances the hydraulic circuit automatically, ensuring that each terminal emitter receives the design flow rate. Even in the case of partial circuit closure by means of the regulating valves, the flow rates in the open circuits **remain constant at the nominal value.** The system always guarantees the greatest comfort and the highest energy savings.

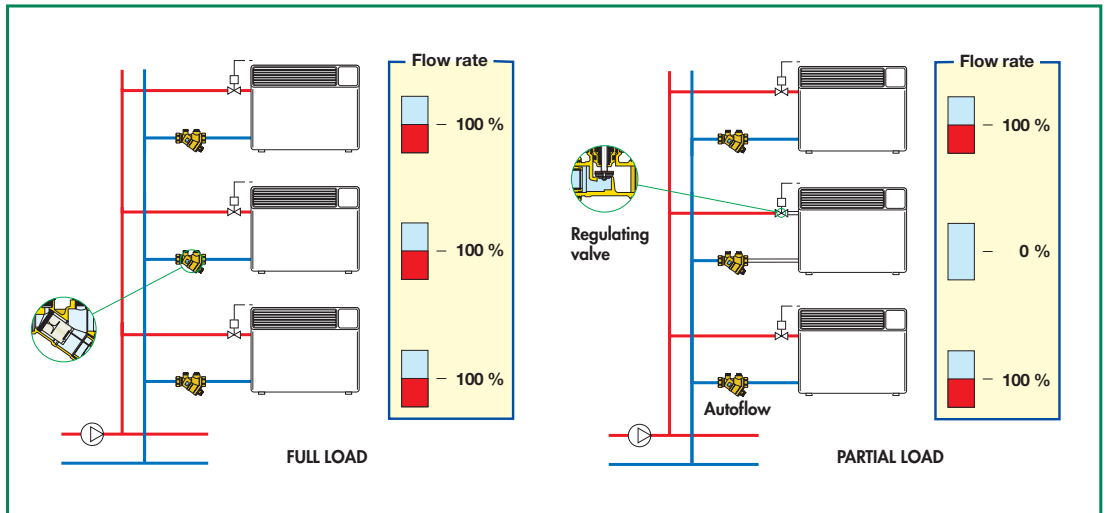

Autoflow devices

Function

The AUTOFLOW device has to guarantee a constant flow rate when its upstream/downstream pressure differential varies.

It is therefore necessary to refer to the Δp - flow rate diagram and a basic diagram illustrating the methods of operation and the effects of the relevant variables.

Principle of operation

The regulating element of these devices is a piston and a cylinder that has side apertures, of fixed and variable geometry, through which the medium flows. These apertures are governed by the movement of the piston on which the thrust of the medium acts. A specially calibrated spring counteracts this movement.

Autoflows are high performance automatic regulators. They regulate the flow rates selected within a very tight tolerance (approx. 10%) and offer a wide range of operation.

Below the control range

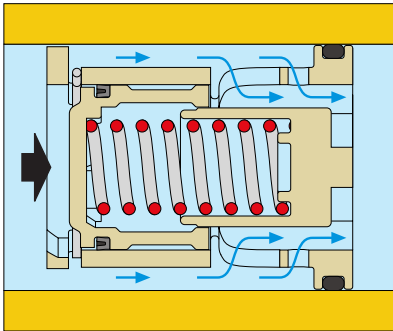

In this case, the regulating piston remains in equilibrium without compressing the spring and gives the medium the maximum free flow area. In practice, the piston acts as a fixed regulator and thus the flow through the AUTOFLOW depends solely on the differential pressure.

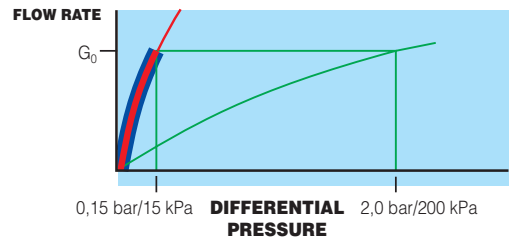
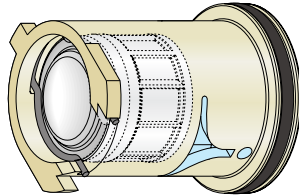

$$K_{V_{0,01}} = 0,258 \cdot G_0 \quad \text{Range } \Delta p \text{ 15-200 kPa} \quad \text{where } G_0 = \text{nominal flow rate}$$

Within the control range

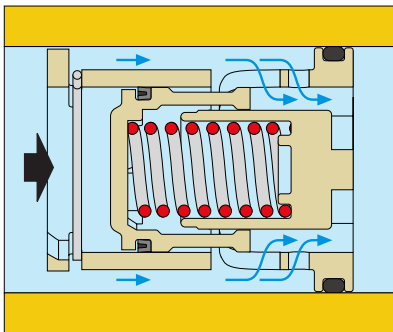

If the differential pressure is contained within the control range, the piston compresses the spring and gives the medium a free flow area to permit regular flow at the nominal rate for which the AUTOFLOW is set up.

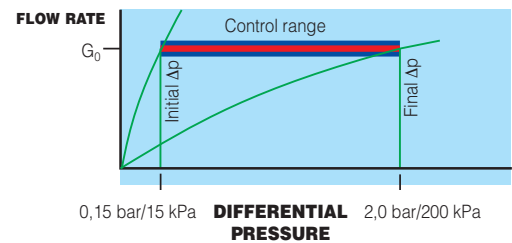
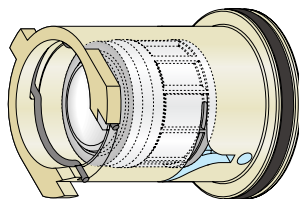

Above the control range

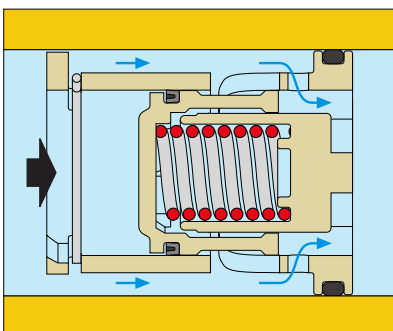

In this case, the piston compresses the spring fully and only leaves the fixed geometry aperture for the medium to pass through.

As in the first case above, the piston acts as a fixed regulator. The flow rate through the AUTOFLOW thus depends solely on the differential pressure.

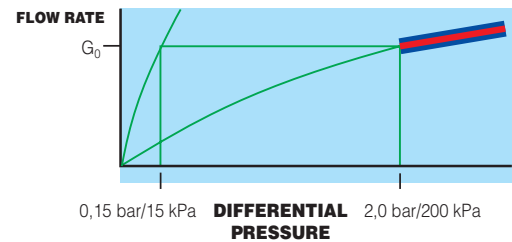
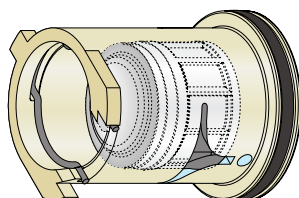

$$K_{V_{0,01}} = 0,070 \cdot G_0 \quad \text{Range } \Delta p \text{ 15-200 kPa} \quad \text{where } G_0 = \text{nominal flow rate}$$

Construction details

New polymer regulator

The flow-rate regulator element is made entirely of high-resistance polymer, specially chosen for use in air-conditioning and plumbing systems.

Its mechanical behaviour is excellent in a wide range of working temperatures, it features high resistance to abrasion due to the medium flowing continuously, it is insensitive to the deposit of scale and is fully compatible with the glycols and additives used in circuits.

Exclusive design

The new regulator, thanks to its exclusive design, is able to accurately regulate the flow rate in a wide range of operating pressures. A special internal chamber acts as a damper for the beating and vibration triggered by the flow of the medium, making sure the device works quietly.

For these reasons it can be used in system circuits on both zone outlets and directly at the terminal emitters.

Ball valve

The control stem of the ball valve has a blowout-proof stem and the reversible closing lever is covered with vinyl. If there are any insulated pipes, it can be changed with the extended lever series 117.

Replaceable cartridge

The internal regulator is assembled in the form of a self contained cartridge so as to permit easy removal from the body for inspection or replacement. It is equipped with a special automatic fixing system with wire and an operating ring for fast and safe positioning without using tools.

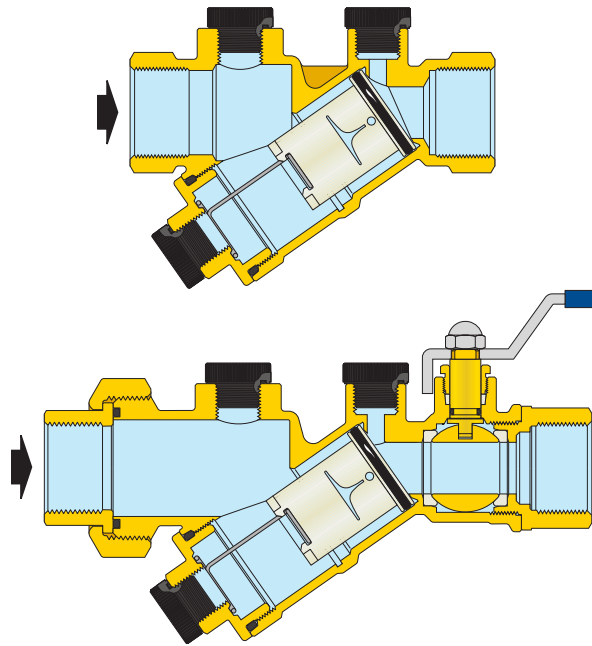
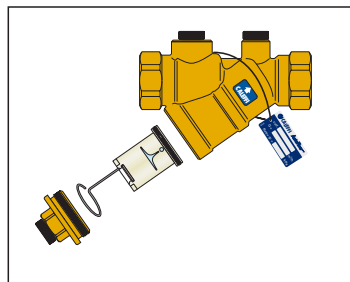

Connecting the device

The body of the Autoflow device is fitted with connections for the pressure ports, which is useful when checking operation in the working range. In addition, the cartridge plug contains a connection to be able to use a circuit drain valve.

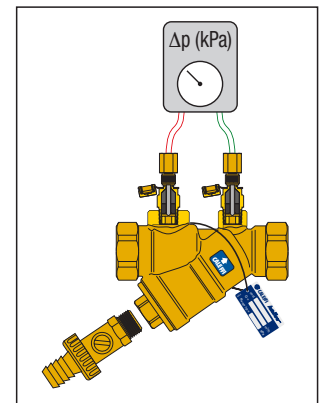

Sizing the circuit with Autoflow

Sizing the circuit containing Autoflow is particularly easy to accomplish. As illustrated by the diagrams, shown alongside by way of example, the calculation of the loss of head for choosing the pump is made by referring to the hydraulically most unfavourable circuit and adding this value to the minimum differential pressure required by the Autoflow. In the example the circuits have the same nominal flow rate.

The Autoflow devices, located on intermediate circuits, automatically absorb the excess differential pressure to ensure the corresponding nominal flow rate.

As the regulating valves open or close, the Autoflow repositions itself dynamically to maintain the nominal flow rate (50% load = circuits 3, 5, 7, 8 closed).

For more detailed information on sizing a system with Autoflow, please refer to the 2nd volume of the Caleffi Handbooks and the technical report "Dynamic balancing of hydronic circuits". They give theoretical calculations, numerical examples and notes on the application of the above-mentioned devices in circuits.

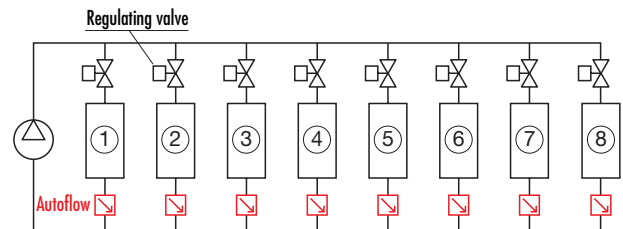

Differential pressures (Δp)

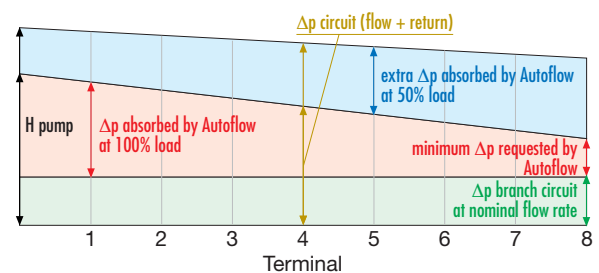

Flow-rate tables

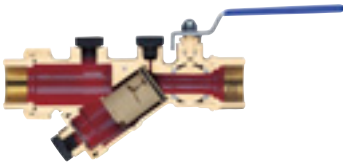

| Code | kv _{0,01} (l/h) | Minimum working Δp (kPa) | Δp Range (kPa) | Flow rates (m ³ /h) |
|--------------------|--------------------------|--------------------------|----------------|--|
| 121 141 ... | 690 | 15 | 15–200 | 0,12; 0,15; 0,2; 0,25; 0,3; 0,35; 0,4; 0,5; 0,6; 0,7; 0,8; 0,9; 1,0; 1,2 |
| 121 151 ... | 773 | 15 | 15–200 | 0,12; 0,15; 0,2; 0,25; 0,3; 0,35; 0,4; 0,5; 0,6; 0,7; 0,8; 0,9; 1,0; 1,2 |
| 121 161 ... | 1.800 | 15 | 15–200 | 0,5; 0,6; 0,7; 0,8; 0,9; 1,0; 1,2; 1,4; 1,6; 1,8; 2,0 |
| 121 171 ... | 1.850 | 15 | 15–200 | 0,5; 0,6; 0,7; 0,8; 0,9; 1,0; 1,2; 1,4; 1,6; 1,8; 2,0 |

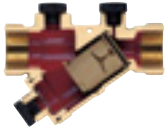

| Code | kv _{0,01} (l/h) | Minimum working Δp (kPa) | Δp Range (kPa) | Flow rates (m ³ /h) |
|--------------------|--------------------------|--------------------------|----------------|--|
| 126 141 ... | 669 | 15 | 15–200 | 0,12; 0,15; 0,2; 0,25; 0,3; 0,35; 0,4; 0,5; 0,6; 0,7; 0,8; 0,9; 1,0; 1,2 |
| 126 151 ... | 758 | 15 | 15–200 | 0,12; 0,15; 0,2; 0,25; 0,3; 0,35; 0,4; 0,5; 0,6; 0,7; 0,8; 0,9; 1,0; 1,2 |
| 126 161 ... | 1.400 | 15 | 15–200 | 0,5; 0,6; 0,7; 0,8; 0,9; 1,0; 1,2; 1,4; 1,6; 1,8; 2,0 |
| 126 171 ... | 1.450 | 15 | 15–200 | 0,5; 0,6; 0,7; 0,8; 0,9; 1,0; 1,2; 1,4; 1,6; 1,8; 2,0 |

Minimum differential pressure required

Given by the sum of two values:

1. The minimum working Δp of the Autoflow cartridge
2. The Δp required for the nominal flow rate to pass through the valve body.

This value can be calculated according to the values of kv_{0,01} stated above and referring to the valve body only

Example

Autoflow 126 series dimension 1" with flow rate G₀ = 1200 l/h and Δp Range 15–200 kPa:

$$\Delta p_{\text{required}} = \Delta p_{\text{Autoflow}} + \Delta p_{\text{body}} = 15 + (G_0 / kv_{0,01})^2 = 15 + (1200 / 1400)^2 = 15,7 \text{ kPa}$$

$$\text{Pump head } H = \Delta p_{\text{circuit}} + \Delta p_{\text{required}}$$

Method of coding for Autoflow series 121 - 126

For correct identification of the device, fill in the form giving series No., size, flow rate and Δp.

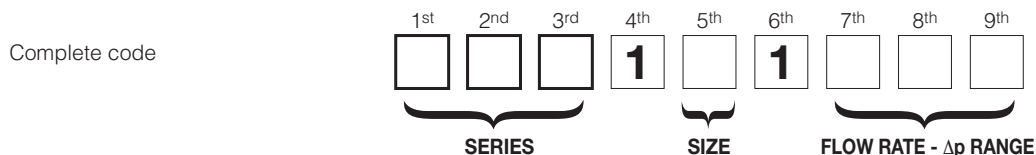

SERIES

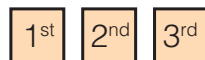

The first three digits indicate the series:

| | |
|-----|-----------------------------------|
| 121 | Autoflow regulator and ball valve |
| 126 | Autoflow regulator |

SIZE



The fifth digit indicates the size:

| | | | | |
|-------|------|------|----|--------|
| Size | 1/2" | 3/4" | 1" | 1 1/4" |
| Digit | 4 | 5 | 6 | 7 |

FLOW RATE AND Δp RANGE



The last three digits indicate the flow rates available.

with Δp Range 15–200 kPa

| m ³ /h | digit | m ³ /h | digit | m ³ /h | digit | m ³ /h | digit | m ³ /h | digit | m ³ /h | digit |
|-------------------|-------|-------------------|-------|-------------------|-------|-------------------|-------|-------------------|-------|-------------------|-------|
| 0,12 | M12 | 0,25 | M25 | 0,40 | M40 | 0,70 | M70 | 1,00 | 1M0 | 1,60 | 1M6 |
| 0,15 | M15 | 0,30 | M30 | 0,50 | M50 | 0,80 | M80 | 1,20 | 1M2 | 1,80 | 1M8 |
| 0,20 | M20 | 0,35 | M35 | 0,60 | M60 | 0,90 | M90 | 1,40 | 1M4 | 2,00 | 2M0 |

Applications of Autoflow ()

Installation of Autoflow

In air-conditioning systems, AUTOFLOW devices must preferably be installed on the circuit return pipe. Some typical installation examples are given below.

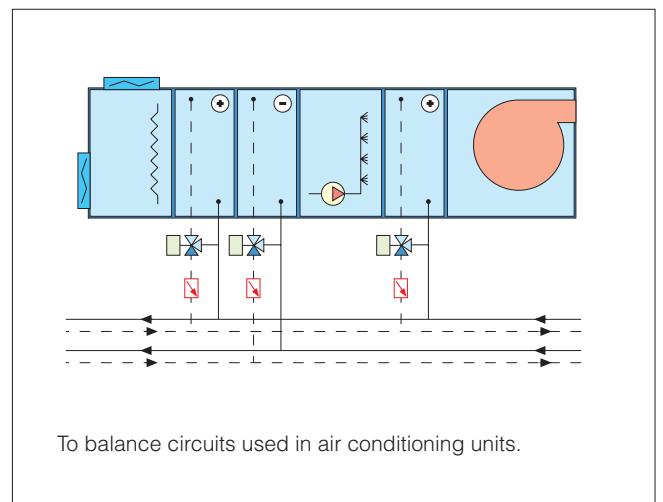
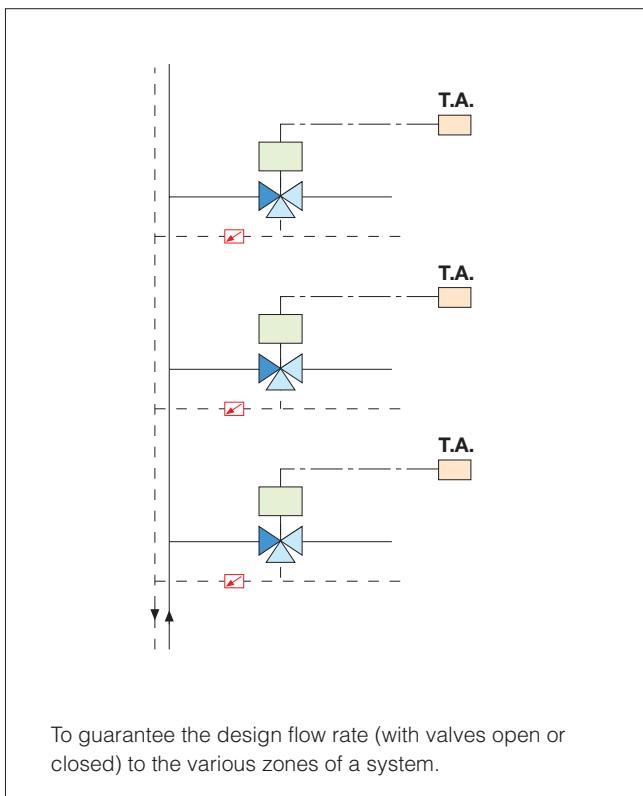
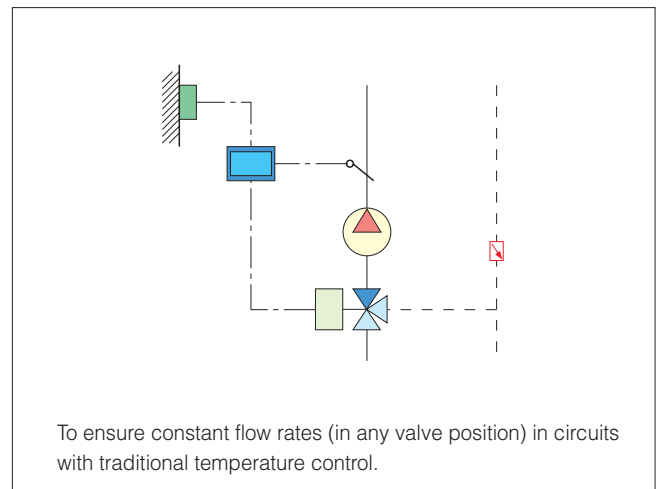
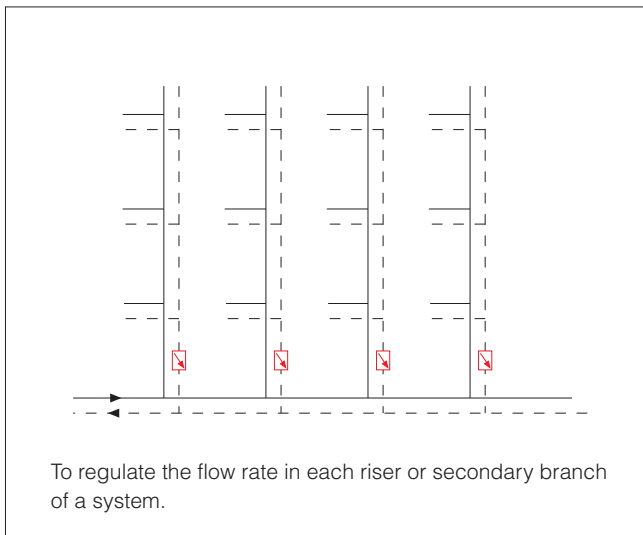
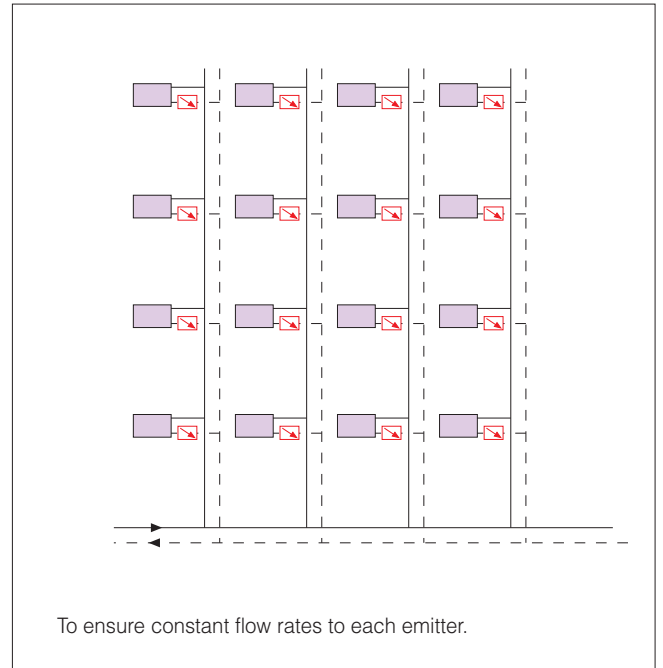
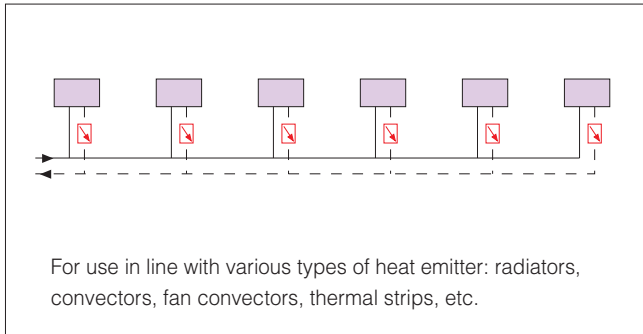

Applications of Autoflow ()

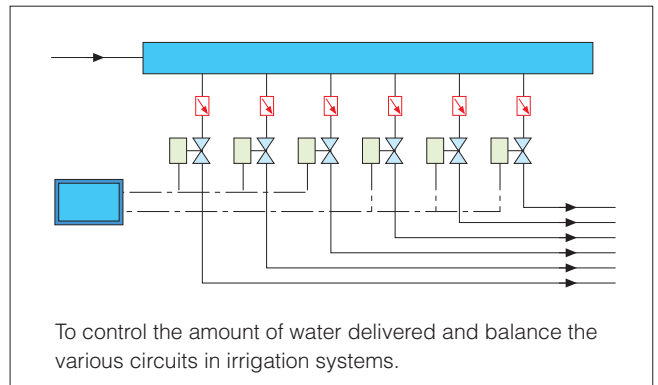
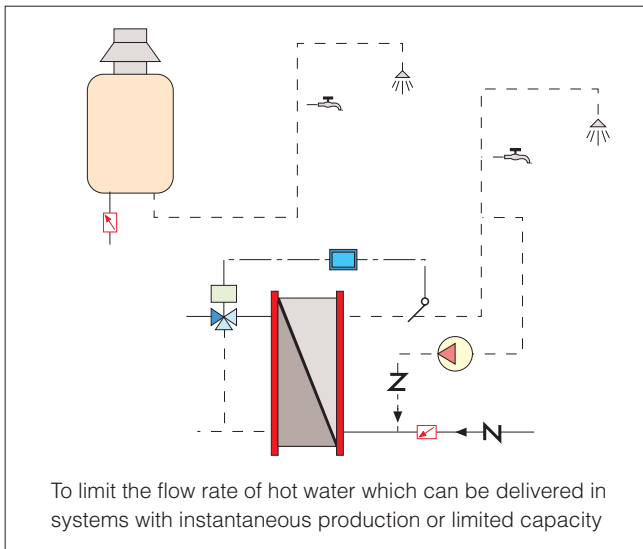
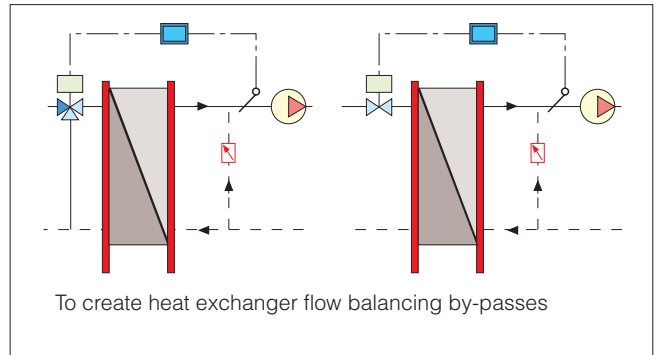
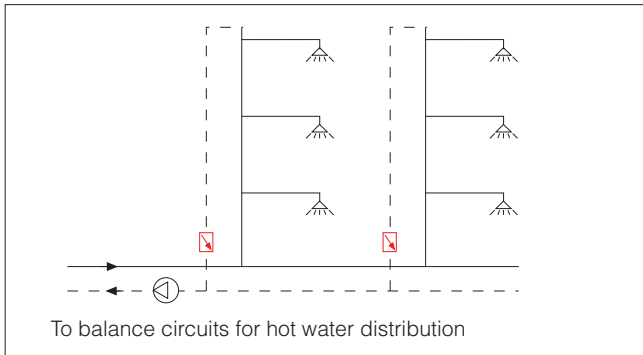

For further details, consult Applications Sheets Nos. 04301, 04302, 04303 and the technical report "Dynamic Balancing of Hydronic Systems".

Accessories

120 FILTER Version

 tech. broch. 01041

Combination of filter and ball valve.

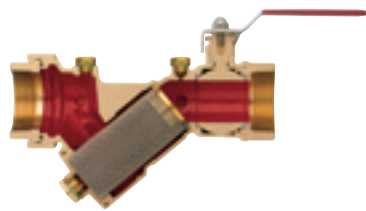

Brass body.
Stainless steel filter cartridge.
Maximum working pressure: 25 bar
Temperature range: 0–110°C
Filter mesh Ø: 1/2"-1 1/4": 0,87 mm
Fitted for connecting pressure ports and drain valve.

| Code | | kv _{0,01} (l/h) |
|------------|--------|--------------------------|
| 120141 000 | 1/2" | 687 |
| 120151 000 | 3/4" | 725 |
| 120161 000 | 1" | 1.665 |
| 120171 000 | 1 1/4" | 1.723 |

Head losses

- The stated values of kv_{0,01} refer to the body of the device with filter.

125 FILTER Version

 tech. broch. 01041

Y-filter.



Brass body.
Stainless steel filter cartridge.
Maximum working pressure: 25 bar
Temperature range: -20–110°C
Filter mesh Ø: 1/2"-1 1/4": 0,87 mm
Fitted for connecting pressure ports and drain valve.

| Code | | kv _{0,01} (l/h) |
|------------|--------|--------------------------|
| 125141 000 | 1/2" | 688 |
| 125151 000 | 3/4" | 705 |
| 125161 000 | 1" | 1.410 |
| 125171 000 | 1 1/4" | 1.494 |

Head losses

- The stated values of kv_{0,01} refer to the body of the device with filter.



130 FLOMET

Electronic flow rate and differential pressure measuring station. Supplied complete with hoses and connection fittings.

Can be used for checking the correct operation of Autoflow devices.

It can also be used for measuring the flow rate of balancing valves series 131, 135 and of the flow metering device 683 series.

Transducer range: 0,05–200 kPa. Max. differential pressure: 200 kPa.

Code

| | |
|--------|------------------|
| 130000 | supply 230 V |
| 130001 | battery operated |

tech. broch. 01041



100

Fast-plug pressure/temperature test ports for automatic flow regulators.

Their special construction permits making rapid and accurate measurements while ensuring leaktightness.

Can be used for:

- checking the operation of Autoflow device;
- checking the degree of strainers clogging;
- checking the heat output of the emitter terminals.

Cap cover facing available in:

- - **Red** for upstream pressure
- - **Green** for downstream pressure.



Brass body.

EPDM seals.

Working temperature range: -5–130°C

Max. working pressure: 30 bar.

Code

| | |
|--------|------|
| 100000 | 1/4" |
|--------|------|



117

Dual-purpose ball valve control handle:

- valve open/close control possible, even when insulation is fitted thanks to extended lever;
- memory stop position by means of mechanically-locking selector.

Useful if you want to create a certain loss of head in the user circuit and you want to keep it even after subsequently closing and reopening the valve.

Code Use

| | |
|--------|----------------------------|
| 117000 | 120, 121 series 1/2", 3/4" |
| 117001 | 120, 121 series 1", 1 1/4" |



100

Pair of fittings with fast-coupling syringe for connection of pressure ports to measuring instruments.

Female 1/4" threaded connection.

Max. working pressure: 10 bar.

Max. working temperature: 110°C.

Code

| | |
|--------|------|
| 100010 | 1/4" |
|--------|------|



538

Drain cock with hose connection.

Code

| | |
|--------|------|
| 538201 | 1/4" |
| 538401 | 1/2" |

SPECIFICATION SUMMARIES

121 series

Automatic flow regulator and ball valve, Autoflow. Brass body. High-resistance polymer cartridge. Stainless steel spring. EPDM seals. Chrome-plated brass ball. PTFE ball seat and stem seal. Zinc-plated steel lever. POM pressure port plugs. Medium: water and glycol solutions. Maximum percentage of glycol 50%. Maximum working pressure 16 bar. Temperature range 0–100°C. Accuracy ± 10%. Δp Range 15–200 kPa. Range of available flow rates: 0,12–2,0 m³/h. Connections 1/2" (3/4", 1" and 1 1/4") F with union x F.

126 series

Automatic flow regulator, Autoflow. Brass body. High-resistance polymer cartridge. Stainless steel spring. EPDM seals. POM pressure port plugs. Medium: water and glycol solutions. Maximum percentage of glycol 50%. Maximum working pressure 16 bar. Temperature range 0–100°C. Accuracy ± 10%. Δp Range 15–200 kPa. Range of available flow rates: 0,12–2,0 m³/h. Connections 1/2" (3/4", 1" and 1 1/4") F x F.

We reserve the right to change our products and their relevant technical data, contained in this publication, at any time and without prior notice.

